

BENINCA®

CENTRALE DI COMANDO

CONTROL UNIT

STEUEREINHEIT

CENTRALE DE COMMANDE

CENTRAL DE MANDO

CENTRALKA STEROWANIA

brain

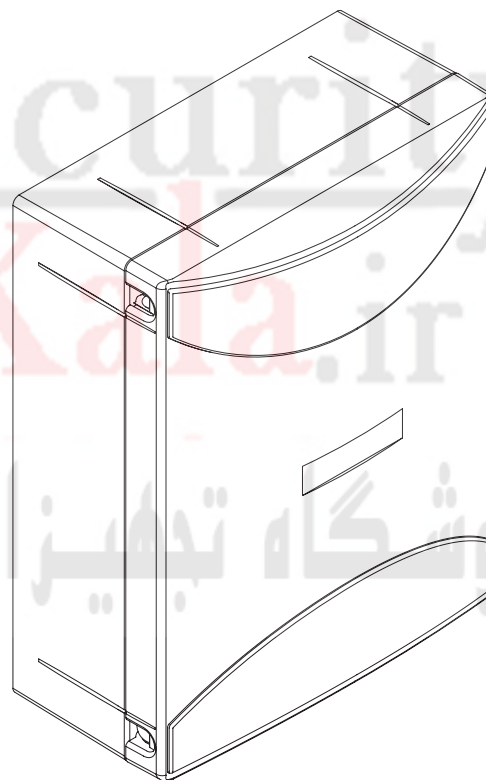

Security
Kala.ir

فروشگاه تجهیزات حفاظتی و امنیتی

Libro istruzioni

Operating instructions

Betriebsanleitung

Livret d'instructions

Manual de instrucciones

Książeczka z instrukcjami



UNIONE NAZIONALE COSTRUTTORI
AUTOMATISMI PER CANCELLI, PORTE,
SERRANDE ED AFFINI

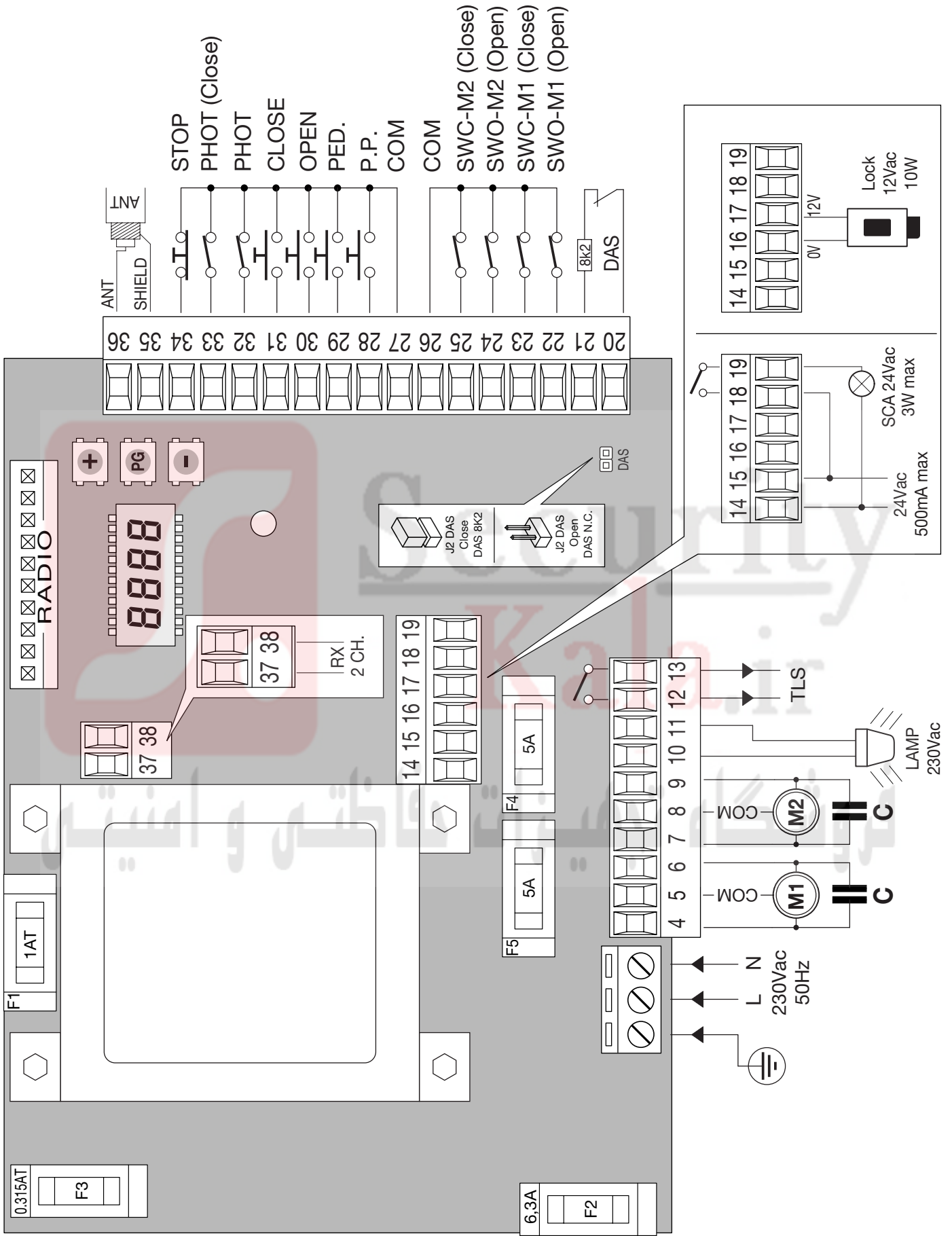

BRAIN control unit

The **BRAIN** electronic control unit may be used for the control of 1 or 2 motors with power not higher than 500W+500W.

GENERAL WARNINGS

- The electrical installation and the operating logic must comply with the regulations in force.
- The leads fed with different voltages must be physically separate, or they must be suitably insulated with additional insulation of at least 1 mm.
- The leads must be secured with an additional fixture near the terminals.
- Check all the connections again before switching on the power.
- The unused N.C. inputs must be bridged.

INPUT/OUTPUT FUNCTIONS

BRAIN Control unit		
N° Terminals	Function	Description
1-2-3	Power supply	Input 230Vac 50Hz (1-GND/2-Phase/3-Neutral)
4-5-6	Motor 1	Connection of motor 1: (4-start/5-Com/6-start)
7-8-9	Motor 2	Connection of motor 2: (7-start/8-Com/9-start)
10-11	Blinking light	Connection of blinking light 230Vac 40W max.
12-13	TLS	N.O. clean contact for courtesy light, timer, etc. The activation time is regulated by the parameter TLS
14-15	24 Vac	Accessories power supply output 24Vac/0.5A max.
16-17	Lock 12Vac	Accessories power supply output 12Vac/10W for electric lock (16:0V, 17:+12V)
18-19	SCA	N.O. clean contact for gate open warning light.
20-21	EDGE	Input, sensitive edge contact Resistive edge: "DAS" Jumper closed Mechanical edge: "DAS" Jumper open When the edge is activated, the gate movement is stopped and reversed for about 3s.
22	SWO-M1	OPEN limit switch input motor 1 (N.C. contact.)
23	SWC-M1	CLOSE limit switch input motor 1 (N.C. contact)
24	SWO-M2	OPEN limit switch input motor 2 (N.C. contact)
25	SWC-M2	CLOSE limit switch input motor 2 (N.C. contact)
26-27	COM	Common for limit switch and all the control inputs.
28	Step-by-Step	Step-by-Step button input (N.O. contact)
29	PED	Pedestrian button input (N.O. contact)
30	OPEN	OPEN button input (N.O. contact), configurable as Clock contact
31	CLOSE	CLOSE button input (N.O. contact)
32	PHOT	Active photocell input on opening and closing
33	PHOT CLOSE	Active photocell input only on closing
34	STOP	STOP button input (N.C. contact)
35-36	Antenna	Antenna connection for plug-in radio receiver board (35-screen/36-signal).
37-38	RX 2ch.	Second radio channel output of the plug-in receiver. Voltage-free N.O. contact.
J3	Radio	Plug-in connector for radio receiver.

Notes:

The EDGE must be connected exclusively to the special inputs 20/21. Two types of EDGE may be used:

If an edge with resistance 8K2 is used, close the Jumper "DAS".

If a mechanical edge with N.C. contact is used, open the Jumper "DAS".

If the edge is not used, bridge the terminals 20-21 and open the Jumper "DAS".

Programming

The programming of the various functions of the control unit is carried out using the LCD display on the control unit and setting the desired values in the programming menus described below.

The parameters menu allows you to assign a numerical value to a function, in the same way as a regulating trimmer.

The logic menu allows you to activate or deactivate a function, in the same way as setting a dip-switch.

Other special functions follow the parameters and logic menus and may vary depending on the type of control unit or the software release.

To access programming:

- 1 - Press the button <PG>, the display goes to the first menu, Parameters "PAR".
- 2 - With the <+> or <-> button, select the menu you want.
- 3 - Press the button <PG>, the display shows the first function available on the menu.
- 4 - With the <+> or <-> button, select the function you want.
- 5 - Press the button <PG>, the display shows the value currently set for the function selected.
- 6 - With the <+> or <-> button, select the value you intend to assign to the function.
- 7 - Press the button <PG>, the display shows the signal "PRG" which indicates that programming has been completed.

Notes:

Simultaneously pressing <+> and <-> from inside a function menu allows you to return to the previous menu without making any changes.

Simultaneously pressing <+> and <-> when the display is switched off shows the card software release.

Hold down the <+> key or the <-> key to accelerate the increase/decrease of the values.

After waiting 60s the control unit quits programming mode and switches off the display.

Parameters, Logic and Special Functions

The tables below describe the individual functions available in the control unit.

	MENU	FUNCTION	Settable values MIN-MAX-(Default)	MEMO
PARAMETERS	تcA	Automatic closing time. Active only with logic "TCA"=ON. At the end of the set time the control unit orders a closing manoeuvre.	1-240-(40s)	
	تN1	Motor 1 work time. Regulates the maximum duration of the opening and closing manoeuvre of the motor 1. It must be set about 4 sec. longer than the actual travel time of the automatism.	5-180-(24s)	
	تN2	Motor 2 work time. Regulates the maximum duration of the opening and closing manoeuvre of the motor 2. It must be set about 4 sec. longer than the actual travel time of the automatism.	5-180-(24s)	
	تPEd	Pedestrian opening time. Regulates the duration of the pedestrian opening manoeuvre of the motor 1.	5-180-(10s)	
	PN1	Motor 1 torque. Regulates the torque applied on the motor 1. RESPECT THE REGULATIONS IN FORCE!	1-99-(40%)	
	PN2	Motor 2 torque. Regulates the torque applied on the motor 2. RESPECT THE REGULATIONS IN FORCE!	1-99-(40%)	
	تdNo	Mot.2 opening delay time. Regulates the delay time of motor 2 on opening with respect to motor 1	0-15-(2s)	
	تdNc	Mot.1 closing delay time Regulates the delay time of motor 1 on closing with respect to motor 2	0-40-(3s)	
	تLS	TLS contact activation time. At each manoeuvre the contact closes for the set time.	1-240-(60s)	
	تLoc	Electric lock activation time. If the electric lock is not used, set the parameter at 0.	0-5-(3s)	
	تSN1	Motor 1 slowing time Regulates the duration of the slowing phase of motor 1 on opening and closing. The set time is subtracted from the motor 1 work time (TM1), which must always be higher.	1-30-(7s)	
	تSN2	Motor 2 slowing time Regulates the duration of the slowing phase of motor 2 on opening and closing. The set time is subtracted from the motor 2 work time (TM2), which must always be higher.	1-30-(7s)	
	PSL1	Motor 1 slowing torque Regulates the torque applied to motor 1 during the slowing phase	1-99-(70%)	
	PSL2	Motor 2 slowing torque Regulates the torque applied to motor 2 during the slowing phase	1-99-(70%)	

MENU	FUNCTION	Settable values ON-OFF-(Default)	MEMO
tca	Enables or disables automatic closing On: automatic closing enabled Off: automatic closing disabled	(ON)	
ibl	Enables or disables condominium function. Off: condominium function disabled. On: condominium function enabled. The step-by-step impulse or transmitter impulse has no effect during the opening phase.	(OFF)	
scl	Enables or disables rapid closing On: rapid closing enabled. With the gate open or in the opening phase the intervention of the photocell causes automatic closing after 3 s. Active only with TCA:ON. Off: rapid closing disabled.	(OFF)	
sls	Enables or disables slowing. On: Slowing active. Off: Slowing excluded.	(OFF)	
pp	Selects the operating mode of the "Step by step button" and of the transmitter. On: Operation: OPEN > CLOSE > OPEN > Off: Operation: OPEN > STOP > CLOSE > STOP >	(OFF)	
pre	Enables or disables pre-blinking. On: Pre-blinking enabled. Blinking is activated 3s before the motor starts. Off: Pre-blinking disabled.	(OFF)	
han	Enables or disables the inversion stroke function On: Function enabled. Before each opening or closing manoeuvre the control unit orders a manoeuvre of 2s in the opposite direction to facilitate the release of the electric lock. Off: Function disabled.	(OFF)	
blc	Enables or disables the block maintaining function. Recommended for hydraulic motors to keep the leaf resting against the mechanical stop block. On: Block maintaining function enabled. Every 2 hours the control unit makes a closing manoeuvre with a duration of about 3s to keep the leaf in contact. Off: Block maintaining function disabled.	(OFF)	
spn	Enables or disables starting torque function. On: Starting torque enabled. At the start of each manoeuvre for 2s the motor operates at maximum torque. Off: Starting torque disabled.	(ON)	
ltca	Selects the operating mode of the blinking light during the time TCA On: Blinking light on during TCA Off: Blinking light off during TCA	(OFF)	
cloc	Selects the mode of the OPEN input On: OPEN input with CLOCK function. To be used for connection to a timer for timed opening/closing. (Contact CLOSED- gate open, Contact open, normal operation).	(OFF)	
htr	Enables or disables Man present function. On: Man Present operation. The OPEN/CLOSE buttons must be held down during the whole manoeuvre. Off: Automatic operation.	(OFF)	
nloc	Selects the type of electric lock used. On: Magnetic electric lock, normally fed at 12Vac. Before each opening manoeuvre the power supply is interrupted for the time set by the parameter TLOC. Off: Electric lock with latch, normally not fed. Before each opening manoeuvre power is fed at 12Vac for the time set by the parameter TLOC.	(OFF)	

LOGIC

	MENU	FUNCTION	Settable values ON-OFF-(Default)	MEMO
LOGIC	<i>inot</i>	Select the 1/2 motors operating mode: On: only one motor (motor 1) active. Function to be used in the following cases: - for single motor, to connect M1:4-5-6. - for two synchronized motors (for instance overhead door), to connect M1:4-5-6 and M2:7-8-9. You need to regulate the parameters related to the motor 1, the limit switch entries M2 are disarmed (not activate). Off: Both motors operating.	(OFF)	
	<i>not</i>	The calculation of residual operating time is activated or deactivated in the event of partial operations: On: Calculation of deactivated time. In case of partial operations, the operating time is reset. The following operation restarts for the entire time preset by parameter TM1/TM2. Off: Calculation of activated time. In case of partial operations, the operating time is stored in memory and then subtracted from the TM1/TM2 parameter value in the following operation.	(ON)	













MENU	FUNCTION
<i>rES</i>	RESET of the control unit. ATTENTION!: Returns the control unit to the default values. Pressing the <PG> button for the first time causes blinking of the letters RES, pressing the <PG> button again resets the control unit.
<i>nnAn</i>	Displays the number of complete cycles (open+close) carried out by the automation. When the <PG> button is pressed for the first time, it displays the first 4 figures, the second time it shows the last 4. Example <PG> 0012 >>> <PG> 3456: made 123.456 cycles.

Example of programming

Let us suppose it is necessary to:

- set an automatic closing time (TCA) of 100s
- activate pre-blinking

Perform the operations described below step by step:



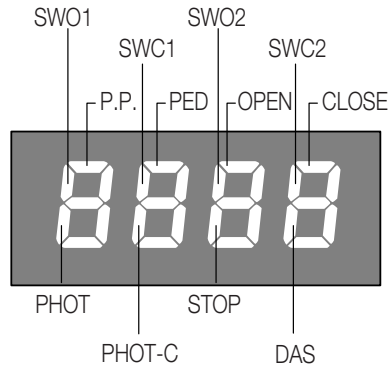

Step	Press	Display	Notes
1		<i>PAR</i>	First menu
2		<i>tCR</i>	First function of the first menu
3		<i>040</i>	Value currently set for the function selected
4		<i>100</i>	Set the desired value with the <+> and <-> keys
5		<i>PrG</i>	The value is programmed
		<i>tCR</i>	When programming has been made, the display goes to the function just set
6		<i>PAR</i>	Press <+> and <-> simultaneously to go to the higher menu
7		<i>LoG</i>	Second menu
8		<i>tCR</i>	First function of the second menu
9		<i>PrE</i>	Press <-> several times to select PRE logic
10		<i>oFF</i>	Value currently set for the function selected
11		<i>on</i>	Set the desired value with the <+> and <-> keys
12		<i>PrG</i>	The value is programmed
		<i>PrE</i>	When programming has been made, the display goes to the function just set
13		<i>PAR</i>	Press <+> and <-> simultaneously to go to the higher menu and quit programming or wait 30s.

Diagnostics

In the event of malfunctions, by pressing key + or - the status of all inputs (limit switches, control and safety) can be displayed. One segment of the display is linked to each input. In the event of failure it switches on according to the following scheme.



N.C. inputs are represented by the vertical segments. N.O. inputs are represented by the horizontal segments.

<p>For example, with the leaves completely closed the display is as follows:</p> 	<p>the moment an Open impulse is given:</p> 	<p>during the opening phase:</p> 	<p>with the leaves completely open:</p> 
--	---	---	---

Security Kala.ir
 فروشگاه تجهیزات حفاظتی و امنیتی

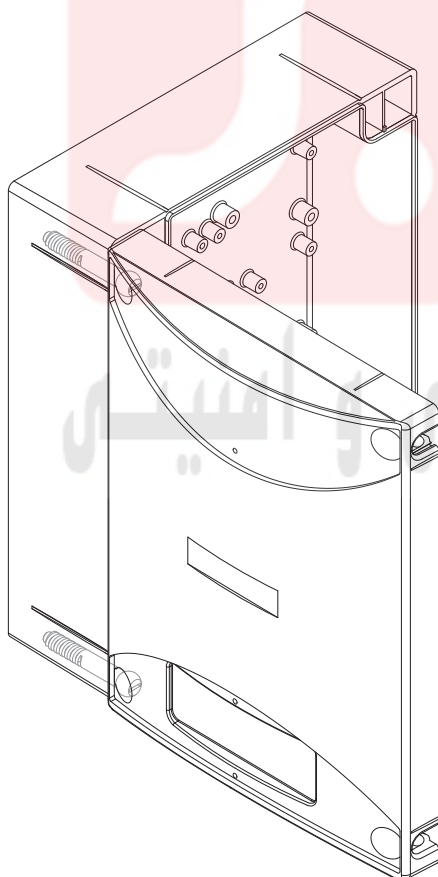
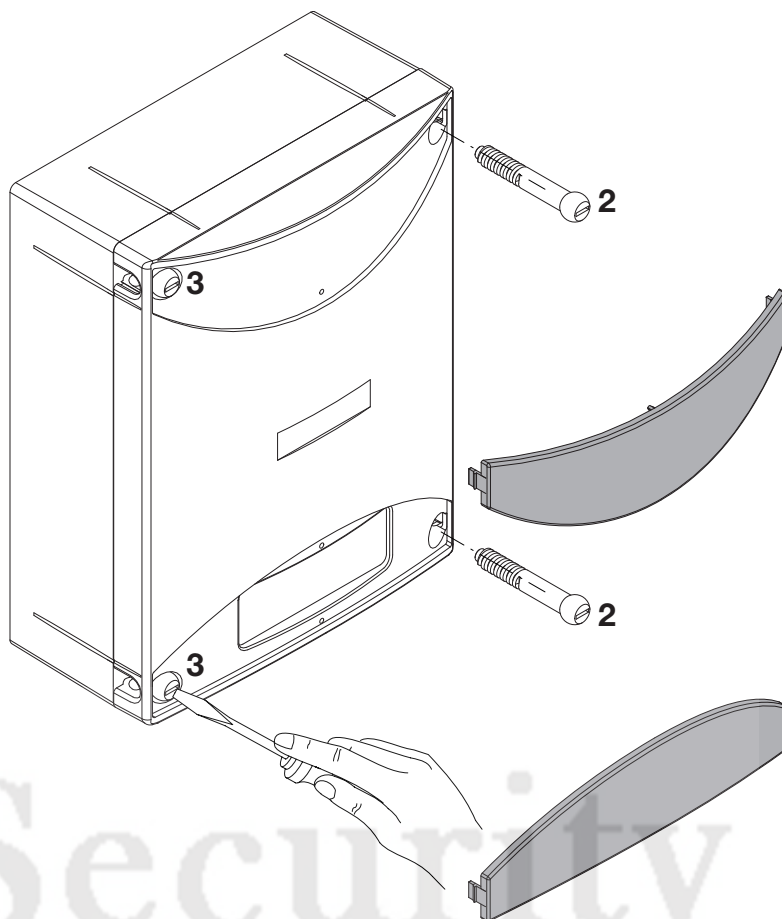
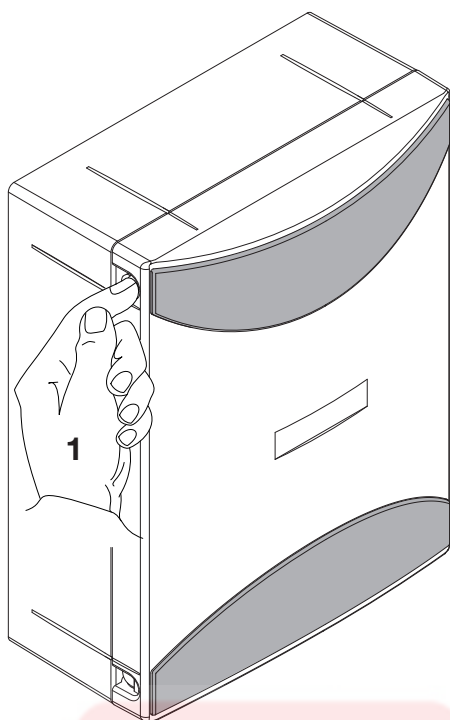

- 1 Premere le alette sui fianchi per sganciare le due maschere copriviti.
- 2 Rimuovere le due viti sul lato di apertura desiderato.
- 3 Allentare le due viti con funzione di cerniera senza rimuoverle, in modo da consentire l'apertura del coperchio.

- 1 Presser les deux ailettes latérales pour décrocher les deux cache-vis.
- 2 Enlever les deux vis sur le côté d'ouverture désiré.
- 3 Desserrer les deux vis faisant fonction de charnière sans les enlever, de manière à permettre l'ouverture du couvercle.

- 1 Press the tabs on the sides to release the two masks that cover the screws.
- 2 Remove the two screws on the desired opening side.
- 3 Slacken the two screws that act as a hinge without removing them, so as to allow opening of the cover.

- 1 Presionar las aletas en los lados para desenganchar las dos tapas cubretornillos.
- 2 Extraer los dos tornillos del lado de apertura deseado.
- 3 Aflojar los dos tornillos con función de bisagra sin extraerlos, a fin de poder abrir la tapa.

- 1 Auf die seitlichen Laschen drücken, so dass die beiden Schraubenblenden befreit werden.
- 2 Die beiden Schrauben an der gewünschten Öffnungsseite ausbauen.
- 3 Zuletzt die beiden als Scharnier dienenden Schrauben lockern, aber nicht ausbauen, damit der Deckel geöffnet werden kann.

- 1 Nacisnąć boczne klapki w celu odhaczenia dwóch masek nakrywających śruby.
- 2 Wyciągnąć dwie śruby po wybranej do otwierania stronie.
- 3 Poluzować dwie śruby blokujące bez wyciągania ich, w sposób umożliwiający otwarcie nakrywki.

BENINCA®